

JRC

Marine ARPA/RADAR system JMA-9900 Series



The marine ARPA/RADAR system employing a 23.1-inch color LCD,
developed with the state-of-the-art technologies and JRC's cultivate experience



Japan Radio Co., Ltd.



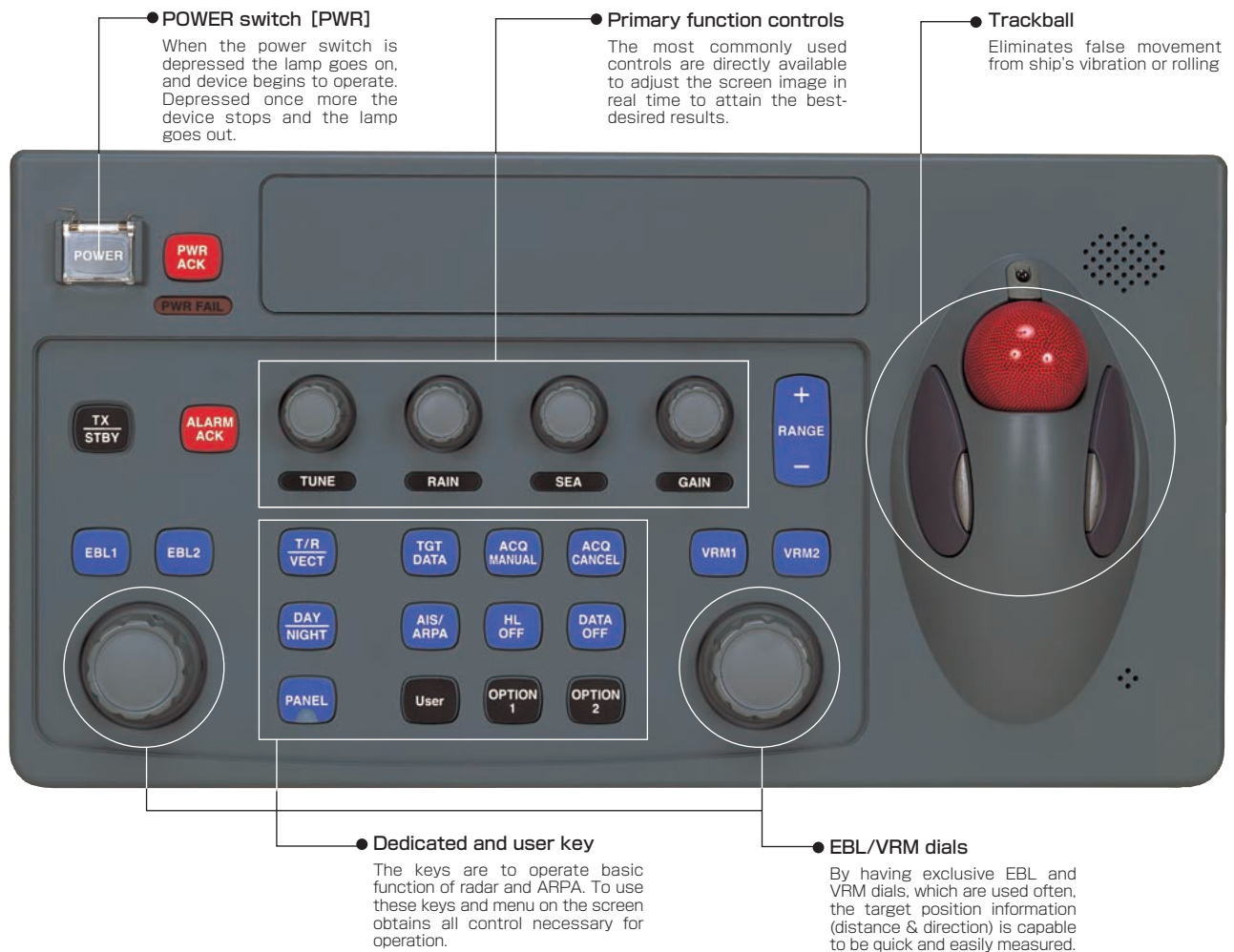

Compliance with IMO performance standards

The X-Band 25kW / S-Band 30kW, 2-unit / 3-unit configuration, 23.1-inch LCD system complies with IMO performance standards.

23.1-inch color TFT display with high resolution

The 23.1-inch LCD display has dimmer that can dim up to approximately 1% of the brightness, making it possible to use the radar at dark conditions during the night.

Enhanced Performance and Functionality

- The software-based digital signal processing of JMA-9900 series radar will provide a superior visibility with automatic control of gain, tune, suppression of sea and rain / snow clutter.
- The enhanced echo-image processing will provide stable target-tracking condition with reducing target loss and transfer to close-by another target.

Simple keyboard and trackball bringing easy operation

- Basic operations and major functions can be operated with the fewest number of carefully chosen direct keys. Particularly, the function that will be frequently accessed is capable to be given to user key.
- The trackball and on-screen-buttons are available for quick access to the function control desired.
- The optical sensor of trackball eliminates false movement from ship's vibration or rolling.

Full Inter-switch Function

Full inter-switching option up to 4 radars. This means that when 4 radars are mounted, any radar can be operated from any of the displays using external inter-switch. 2 Radar Inter-switching is also option component available for built-in.

Bridge system accommodation

Ergonomic console can be easily combined with the ECDIS and the Conning Display allowing for an INS or IBS.

AIS information and interfacing

AIS information and symbols are available to be shown with radar targets on the screen of radar, which is linked with AIS equipment. The cooperation with AIS and radar targets helps decision making of proper maneuvering and safety navigation.

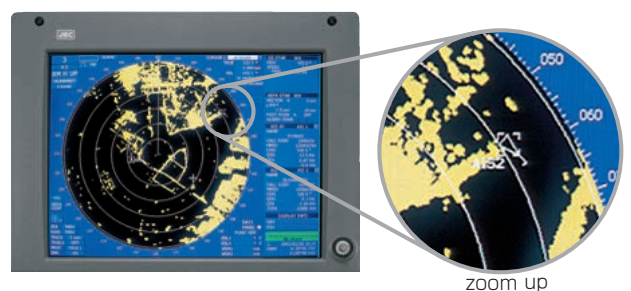

Marine ARPA/RADAR system JMA-9900 Series



The marine ARPA/RADAR system employing a 23.1-inch color LCD, have been developed with the state-of-the-art technologies and JRC's cultivate experience

JRC JMA-9900 series marine ARPA/RADAR system is developed to enhance the radar performance, user-friendly operation and visibility, which meet radar & ARPA performance standards specified in IMO.

The JMA-9900 series adopting a 23.1-inch color LCD monitor has the types of 25kW X-Band / 30kW S-Band scanner, and 2-unit / 3-unit configuration.



Stand-alone



Desk-top

INTRODUCTION

JRC JMA-9900 series ARPA/Radar is developed to enhance the radar performance, user-friendly operation and visibility, which meet the performance standards of radar, ARPA and AIS information indication, which are specified in IMO. The JMA-9900 main functions include; sea and rain/snow clutter suppression, sensitivity adjustment, interference reflector, bearing and range measurement using a trackball, fixed/variable range markers and electronic bearing line, ARPA, and AIS information function. In addition, this has the functions of color display setting, own track display, NAV line and mark display, True Motion presentation, radar performance monitoring and built-in switchover function (Inter-switch) up to 2 radars.

The software-based digital signal processing of JMA-9900 series radar will provide a superior visibility with automatic control of gain, tune, anti-sea-clutter and anti-rain-clutter, which are adjusted for suitable radar condition. Furthermore the enhanced echo-image processing will provide stable target-tracking condition with reducing target loss and transfer to close-by another target.

FEATURES

Tilt-type display bringing superior visibility and effective shading of sunlight

23.1-inch color LCD providing easy interpretation with clear vision

Trackball available for pointing and clicking operation

Dedicated and user keys contributing stress-free operation

Suppression of sea and rain-clutter adjusted automatically

Stable ARPA target-tracking on superior signal processing

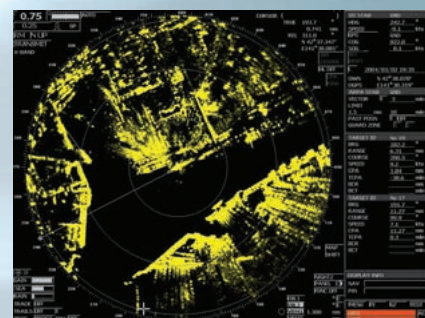
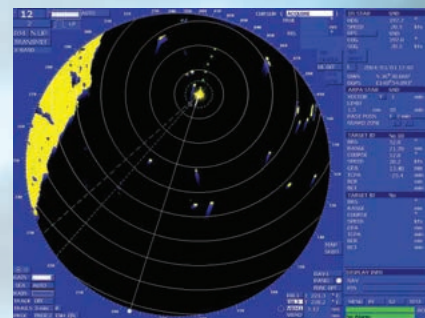
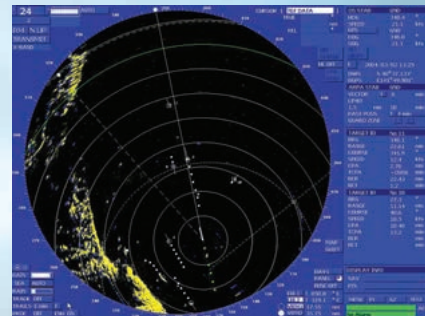

JRC

For further information, contact:



Since 1915

Japan Radio Co., Ltd.

URL <http://www.jrc.co.jp/>

Main Office: Nittochi Nishi-Shinjuku bldg.
10-1, Nishi-Shinjuku 6-chome
Shinjuku-ku, Tokyo 160-8328, Japan
Telephone: +81-3-3348-4099
Facsimile: +81-3-3348-4139

Overseas Branches : Seattle, Amsterdam
Liaison Offices : Taipei, Manila, Jakarta, Singapore,
Hanoi, New York, Athens

JMA-9922-6XA JMA-9922-9XA

X-band
25kW transmitting output



NKE-1087-6 (6 feet)



NKE-1087-9 (9 feet)

JMA-9922-9XA STAND ALONE

NKE-1087PM-6 SCANNER UNIT: MASS APPROX. 55kg W/O Option
NKE-1087PM-9 SCANNER UNIT: MASS APPROX. 60kg W/O Option

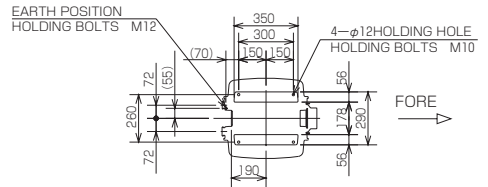
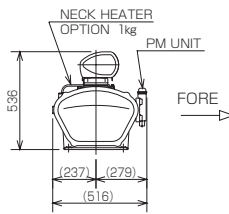
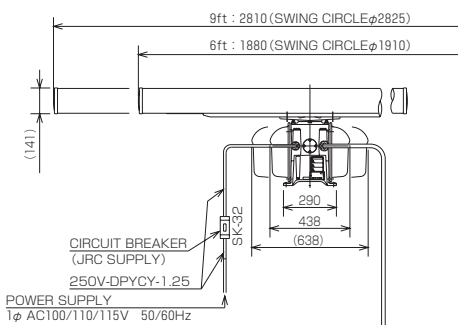

MOUNTING DIMENSIONS

14-CORE COMPOSITE CABLE
H-2695110056 (JRC SUPPLY)

MAX. ϕ 23

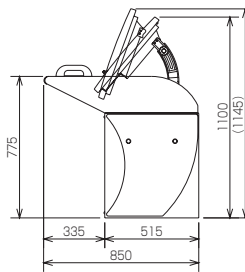
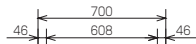

DISPLAY UNIT
NCD-4263 (STAND-ALONE)
MASS APPROX. 130kg

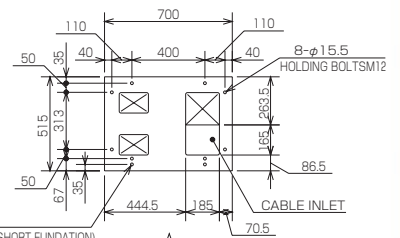

MOUNTING DIMENSIONS

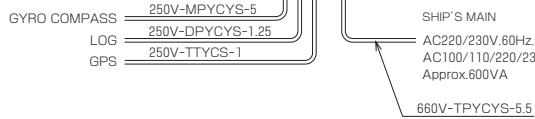

NOTE : In order to eliminate interference from other radio devices while operating the radar, DO NOT run radar cables, especially scanner cables, parallel to that of other radio equipment.

(UNIT:mm)

JMA-9922-6XA JMA-9922-9XA

X-band
25kW transmitting output



NKE-1087-6 (6 feet)



NKE-1087-9 (9 feet)

JMA-9922-9XA DESK TOP

NKE-1087PM-6 SCANNER UNIT: MASS APPROX. 55kg W/O Option
NKE-1087PM-9 SCANNER UNIT: MASS APPROX. 60kg W/O Option

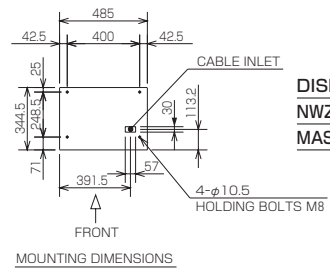
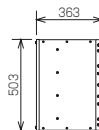
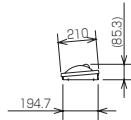
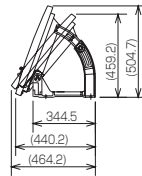
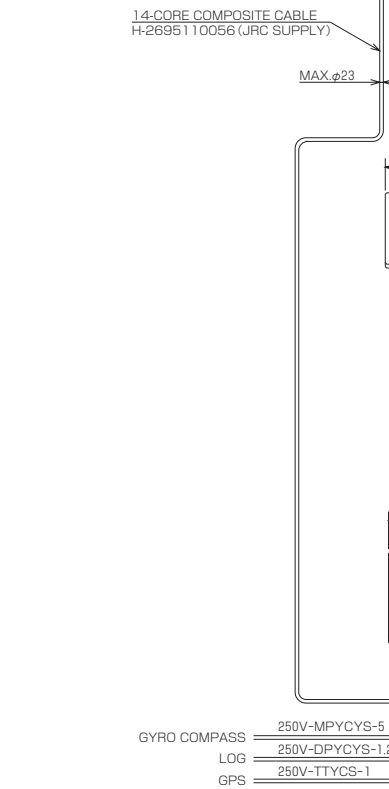
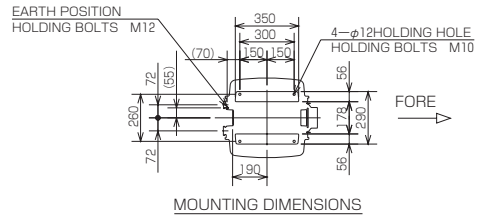
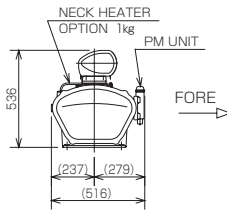
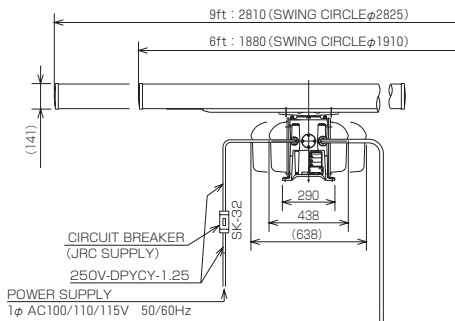

DISPLAY UNIT
NWZ-158 (DESK TOP)
MASS APPROX. 25kg

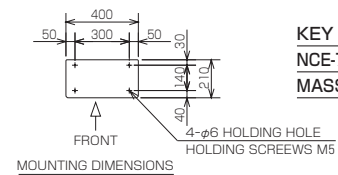

KEY BOARD
NCE-7721 (DESK TOP)
MASS APPROX. 3.1kg

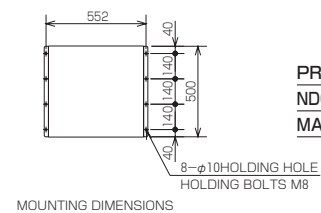

PROCESSOR
NDC-1279T (DESK TOP)
MASS APPROX. 40kg

NOTE : In order to eliminate interference from other radio devices while operating the radar, DO NOT run radar cables, especially scanner cables, parallel to that of other radio equipment.

(UNIT:mm)

JMA-9923-7XA JMA-9923-9XA

X-band
25kW transmitting output



NKE-1089-7 (7 feet)



NKE-1089-9 (9 feet)

Transmitter / Receiver unit



NTG-3028

JMA-9923-9XA STAND ALONE

NKE-1089PM-7 SCANNER UNIT: MASS APPROX. 51kg W/O Option

NKE-1089PM-9 SCANNER UNIT: MASS APPROX. 53kg W/O Option

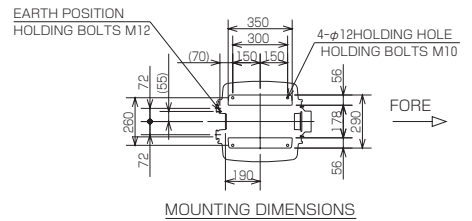
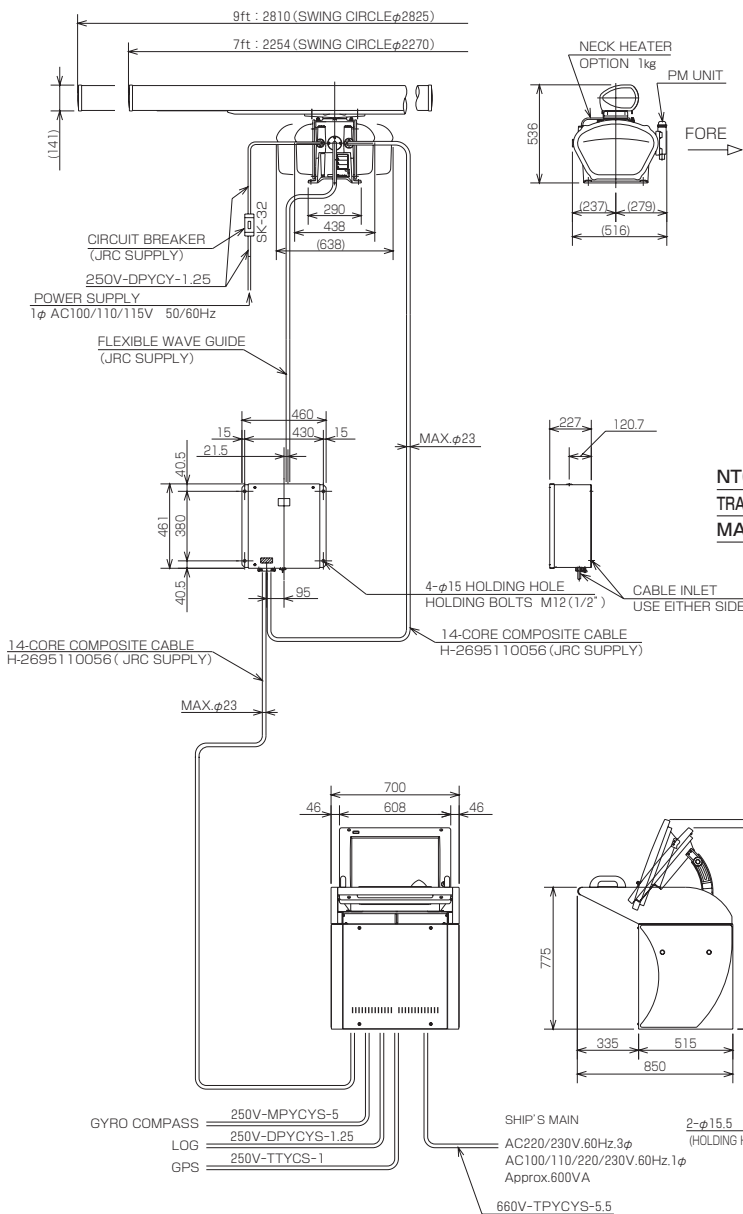

NTG-3028
TRANSMITTER-RECEIVER UNIT
MASS APPROX. 21kg

DISPLAY UNIT
NCD-4263 (STAND-ALONE)
MASS APPROX. 130kg

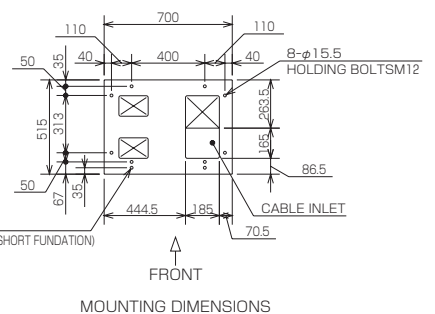

NOTE : In order to eliminate interference from other radio devices while operating the radar, DO NOT run radar cables, especially scanner cables, parallel to that of other radio equipment.

(UNIT:mm)

JMA-9923-7XA JMA-9923-9XA

X-band
25kW transmitting output



NKE-1089-7 (7 feet)



NKE-1089-9 (9 feet)

Transmitter / Receiver unit



NTG-3028

JMA-9923-9XA DESK TOP

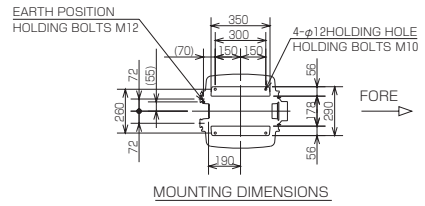
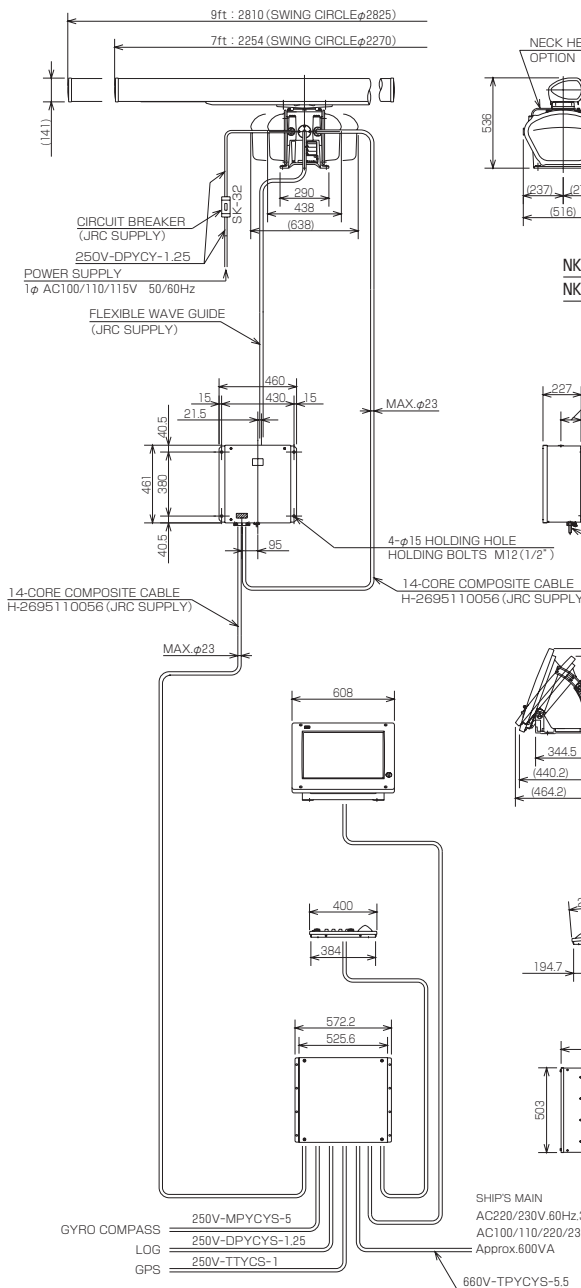

NKE-1089PM-7 SCANNER UNIT: MASS APPROX. 51kg W/O Option
NKE-1089PM-9 SCANNER UNIT: MASS APPROX. 53kg W/O Option

NTG-3028
TRANSMITTER-RECEIVER UNIT
MASS APPROX. 21kg

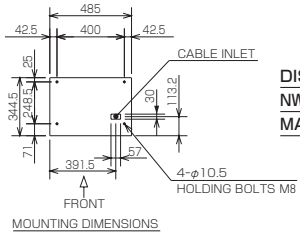

DISPLAY UNIT
NWZ-158 (DESK TOP)
MASS APPROX. 25kg

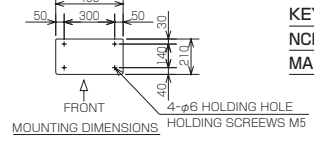

KEY BOARD
NCE-7721 (DESK TOP)
MASS APPROX. 3.1kg

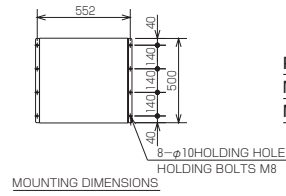

PROCESSOR
NDC-1279T (DESK TOP)
MASS APPROX. 40kg

NOTE : In order to eliminate interference from other radio devices while operating the radar, DO NOT run radar cables, especially scanner cables, parallel to that of other radio equipment.

(UNIT:mm)

JMA-9932-SA

S-band
30kW transmitting output



NKE-1075A-12 (12 feet)

JMA-9932-SA STAND ALONE

NKE-1075APM SCANNER UNIT: MASS APPROX. 165kg W/O Option

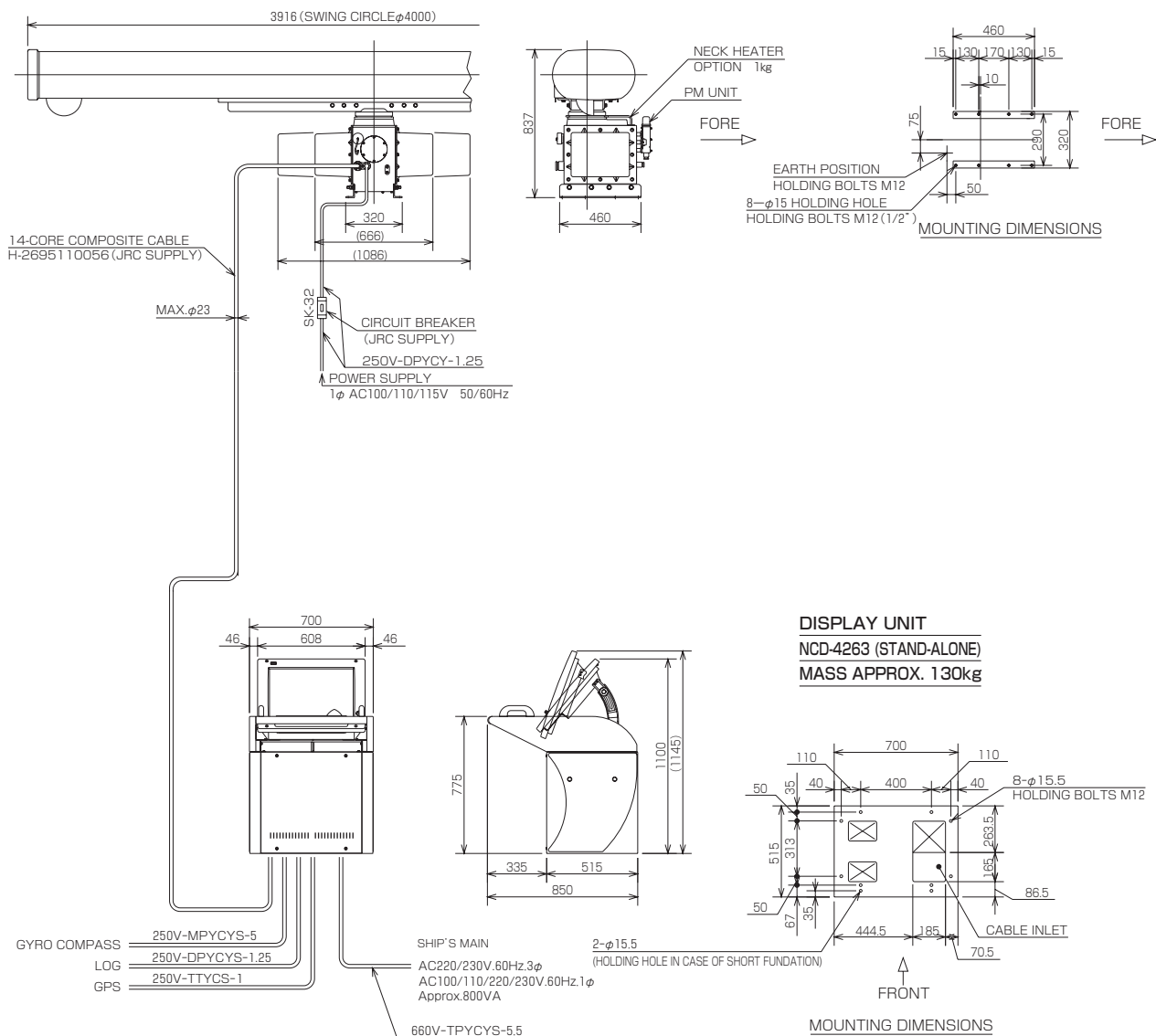

NOTE : In order to eliminate interference from other radio devices while operating the radar, DO NOT run radar cables, especially scanner cables, parallel to that of other radio equipment.

(UNIT:mm)



NKE-1075A-12 (12 feet)

JMA-9932-SA DESK TOP

NKE-1075APM SCANNER UNIT: MASS APPROX. 165kg W/O Option

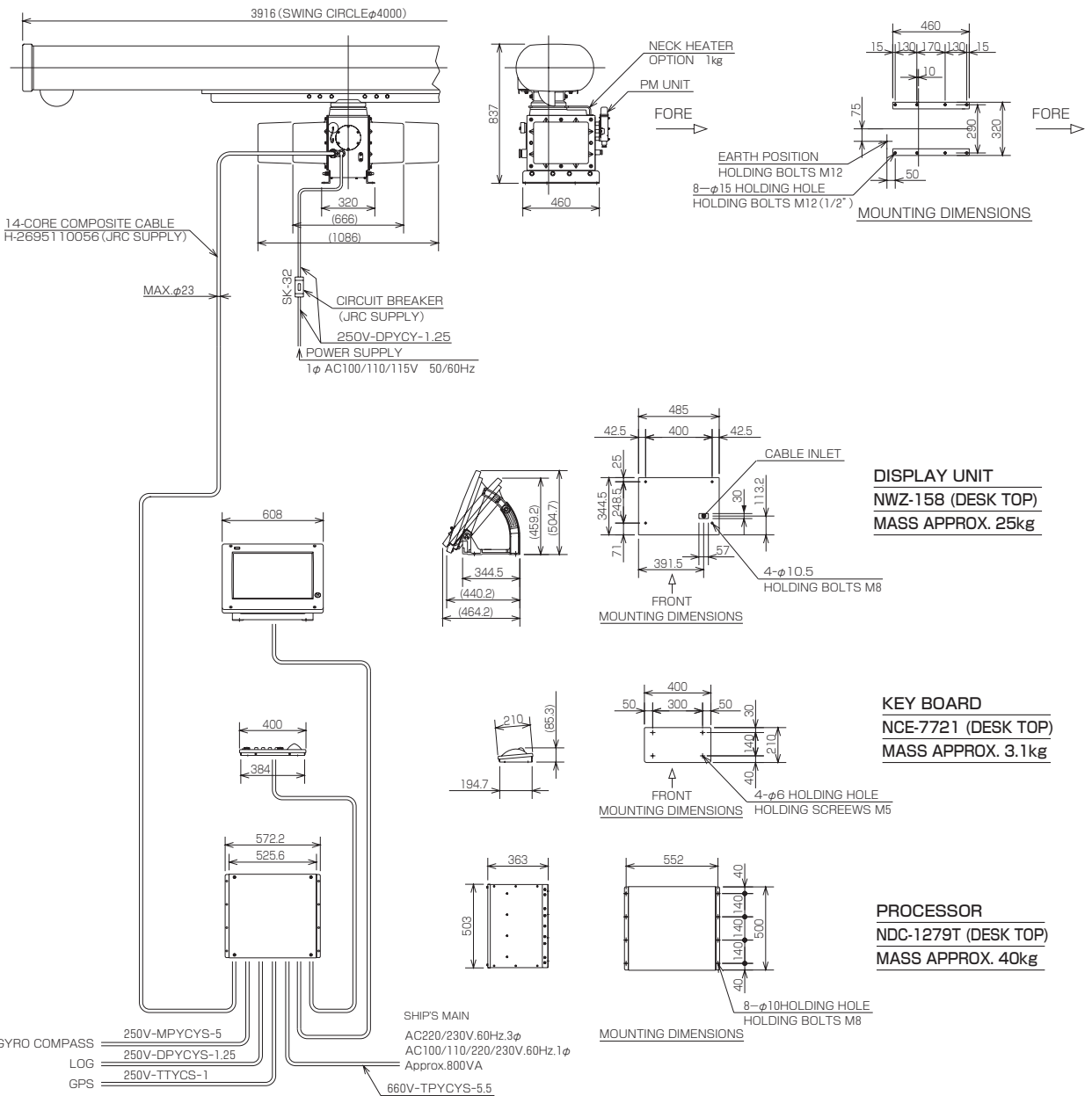

NOTE : In order to eliminate interference from other radio devices while operating the radar, DO NOT run radar cables, especially scanner cables, parallel to that of other radio equipment.

(UNIT:mm)

JMA-9933-SA

S-band
30kW transmitting output

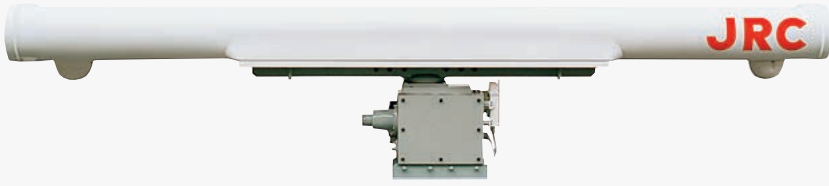

NKE-1079A-12 (12 feet)

Transmitter / Receiver unit



NTG-3037

JMA-9933-SA STAND ALONE

NKE-1079APM SCANNER UNIT: MASS APPROX. 165kg W/O Option

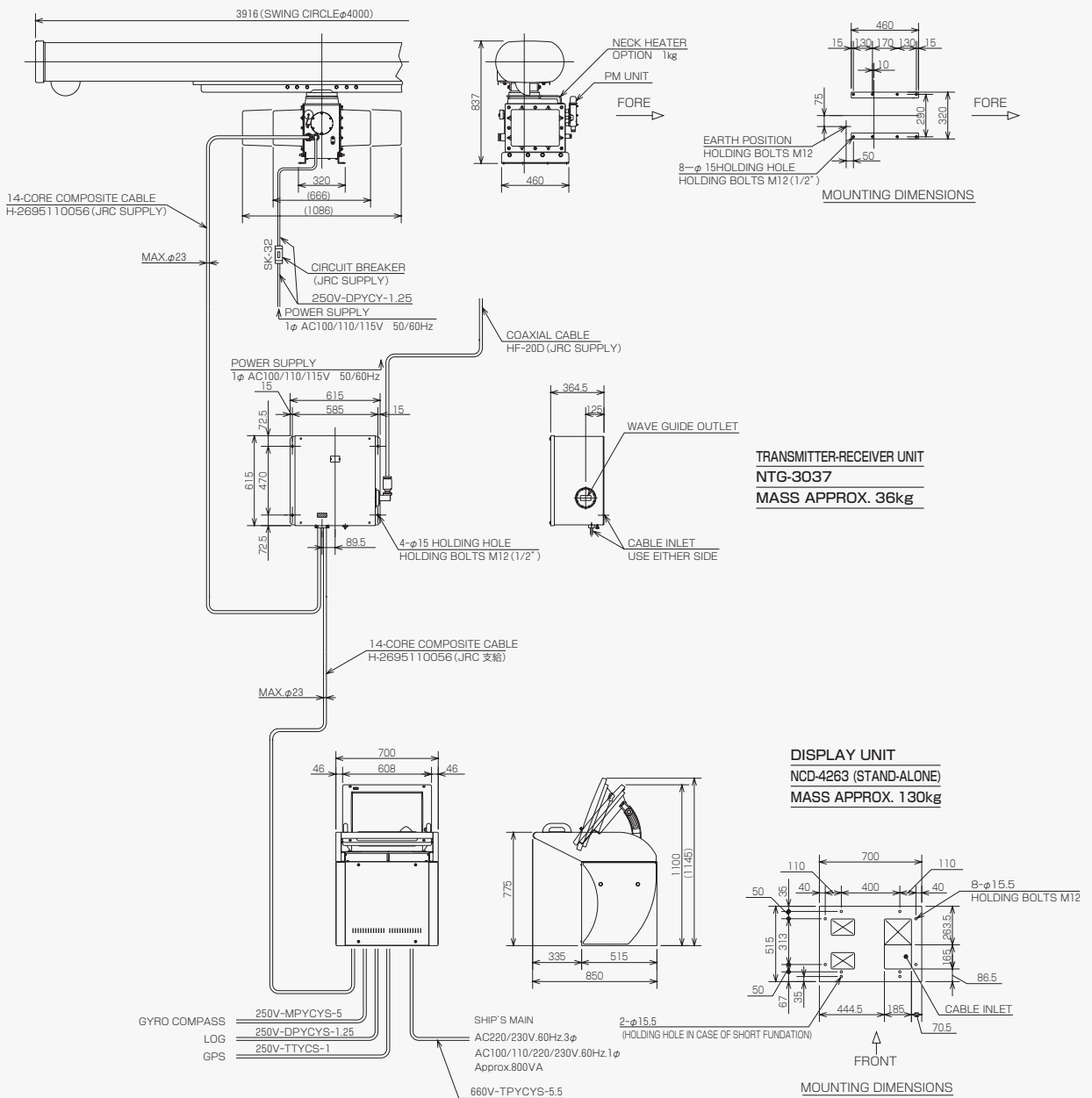

NOTE : In order to eliminate interference from other radio devices while operating the radar, DO NOT run radar cables, especially scanner cables, parallel to that of other radio equipment.

(UNIT:mm)

Specifications for JMA-9900 series

MODEL LIST OF JMA-9900 SERIES RADAR

MODEL	FREQ.	OUTPUT POWER	SCANNER	SCANNER REV.	BEAM WIDTH	POWER SUPPLY / COMSUMPTION	UNIT
JMA-9922-6XA	X-band	25kW	6 feet	26rpm (60Hz)	H:1.2°, V:20°	AC220/230V, 60Hz, 3-phase AC100/110/220/230V, 60Hz, 1-phase Approx.600VA	2
JMA-9922-9XA			9 feet		H:0.8°, V:20°		
JMA-9923-7XA			7 feet		H:1°, V:20°		3
JMA-9923-9XA			9 feet		H:0.8°, V:20°		
JMA-9932-SA	S-band	30kW	12 feet	26rpm (60Hz)	H:1.9°, V:30°	AC220/230V, 60Hz, 3-phase AC100/110/220/230V, 60Hz, 1-phase Approx.800VA	2
JMA-9933-SA							3

SPECIFICATIONS OF PERFORMANCE & FUNCTION

Radar Function

- **Transmitting Frequency and Power**
X-band (9410MHz): 25kW
S-band (3050MHz): 30kW
- **Maximum Detectable Range** : 96nm or 120nm
- **Range Scale** : 0.125 / 0.25 / 0.5 / 0.75 / 1.5 / 3 / 6 / 12 / 24 / 48 / 96 (or 120nm)
- **Range Resolution** : less than 30m
- **Minimum Detectable Range** : less than 40m
- **Bearing Accuracy** : less than 1 degree
- **Pulse Width** : 0.07/0.10/0.15/0.2/0.3/0.6/1.2μsec

Display Function

- **Display** : 23.1-inch Color TFT
(Valid diameter: more than 340mm)
- **Bearing indication** : North-up / Course-up / Head-up
- **Presentation mode** : Relative motion (RM) with True trail / Relative motion (RM) with Relative trail / True motion
- **STC / FTC** : Auto / Manual
- **Trails indication** : 0.5min / 1 min / 3 min / 6 min / OFF
- **Indication of NAV line**
- **Off-Center** within 60% of PPI radius

ARPA Function

- **Acquisition mode** : Auto / Manual
- **Number of Tracking** : 50 targets (Automatic)
- **Acquisition and Tracking Range** : 32nm
- **Display mode** : True Motion (TM) / Relative Motion (RM)
- **Bearing mode** : Head-up / North-up / Course-up
- **Vector mode** : True vector / Relative vector
- **Guard Zone** : 2
- **Parameter of Safe Limit** : CPA : 0.1-9.9nm
TCPA : 1-99min
- **Alarm Indication**: Mark on the display with Visible / Audible Alarm
- **Trial Maneuver**: Manual setting (manual / Auto Reset)

AIS Function

- **Number of AIS target available to indicate** : 50 target
- **AIS Information**
Basic Info : Ship Name, Call sign, MMSI, COG, SOG, CPA, TCPA
Detail Info : Bearing, distance, heading, Rate of turn, ship position (added with basic info)
- **AIS Filtering Parameter** : Distance from own ship, Sector, Zone
- **Dangerous Target Detection Parameter** : CPA, TCPA

Specifications for JMA-9900 series

INPUT SIGNAL INTERFACE

Ship's Speed (Speed Log)

- Pulse : 100/200/400/800pulse/nm
- Synchro : 50-115Vac/90°, 180°, 360°
- NMEA0183 (IEC61162-1) : VBW sentence (available dual axis)

Ship's Heading

- Step : 24-110Vdc/90°, 180°, 360°
- Synchro : 50-115Vac/90°, 180°, 360°

OUTPUT SIGNAL INTERFACE

Screen Image for VDR (Voyage Data Recorder)

- Resolution : 1024×768 pixels
- Video signal (RGB) : 0.5Vp-p, Positive Polarity, 50-ohm
- Horizontal synchro signal: TTL/Negative Polarity
- Vertical synchro signal: TTL/Negative Polarity

Navigation Data

- NMEA0183 (IEC61162-1)
: GLL/GGA/VBW/VTG/RMA/RMB/RMC/ZDA sentence

AIS target information

- Acceptable sentence
: VDM/VDO/ALR sentence
- Interface condition
: IEC61162-2

OPTION COMPONENTS

Unit Name	Type
Heater for X-band scanner	For NKE-1087/1089
Heater for S-band scanner	For NKE-1077/1079
2 radars Inter-switch	NQE-3141-2 (Max.2 radars)
4 radars Inter-switch	NQE-3141-4 (Max.4 radars)
Screen Hood	MPOL30345
Display unit cover	MPXP31889
VDR Interface kit	CQD-1891